



**MOCHTOYS**<sup>®</sup>  
"MOCHTOYS JOY COMPANY"

Inspired by Fun,  
Driven by Passion.

**2025**



## Dear Customer,

*this catalog is the result of the professionalism and passion of the entire Mochtoys team, showcasing our dedication to providing a diverse and exceptional product range. We are proud to introduce our latest product lineup alongside our cherished and popular bestsellers.*

*Explore the collection and let yourself be inspired!*



Owner  
*A. Rodin*

# Why Choose Us?



Expertise in OEM manufacturing



Own tooling workshop



High Quality with ISO 9001:2015



Over 30 years of experience in injection and blow moulding



New items created every year

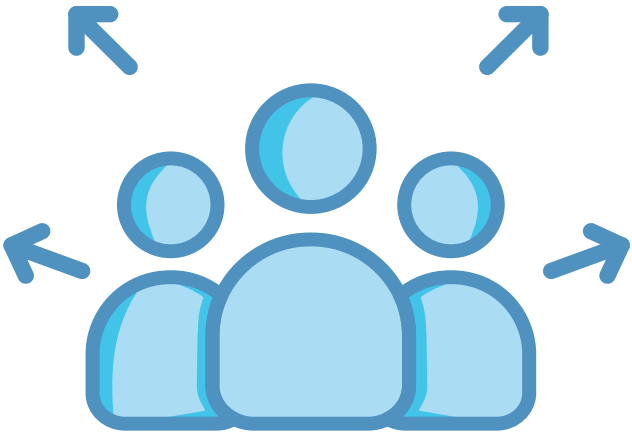

# Facts and figures

Since 1993, we've been developing our company with a focus on innovation and quality.



**1993:** Company founded with one sand set.



**1999:** First factory in Otwock.



**2001:** Launch of the first sandbox.



**2004:** Introduction of IML labels.



**2008:** Expansion with a new factory in Wola Ducka.



**2011:** Premiere of the Garden House.



**2015:** Introduction of the Big Slide.



**2020:** Launch of the modern Happy house.



**2021:** Innovative production from Post Consumer Recyclate.



**2022:** Introduction of the Smart House.



**2023:** Line of toys with Bio Component.





**2024:** Sensory toys - Play & Squish series.

# Commitment to Sustainability

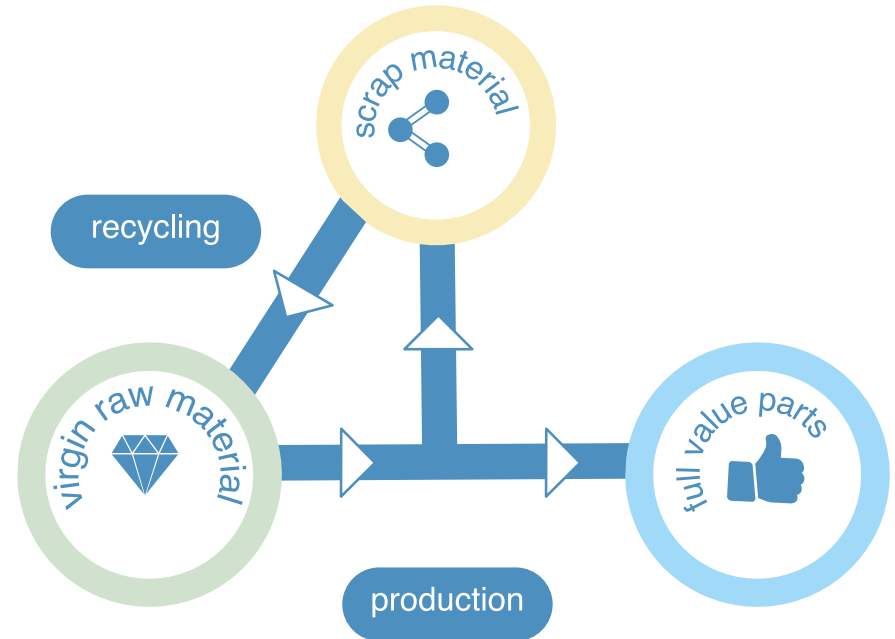
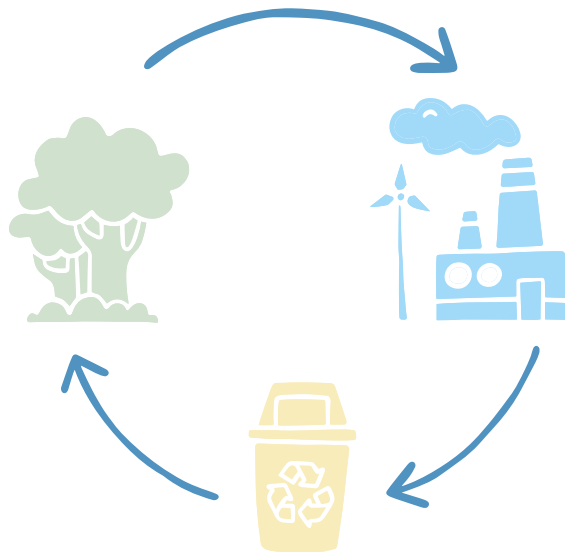
-  Zero waste strategy
-  Environmental policy
-  Energy efficiency
-  Sustainable packagings



	<b>Przemiał Polipropylen</b>			
	Marktykuł:	SPP9023	P1	NR PROD:
	Waga w opak.	16 kg		21/P-01844
	Kolor/Wykonanie Pomarańcz SBP0082/		Opak. zb. worek	
	 00859074421093061416			
Oper:	0034	Sr Prod:	WALCZYK	Data Produkcji:
netto:	16 kg	brutto:	16,07 kg	2021-07-10

Full traceability of milled raw material.

# Our Growth and Innovations



**180+**  
employees



**18000**  
sqm of area

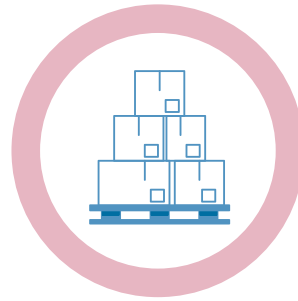

**17000**  
pallets  
warehouse



**30+**  
countries  
reached



**5mln+**  
toys sold  
per year

## BIO innovation



In care of environment we created line of products including bio component based on oats/wood fibers. It allows to use less plastic for the production!



## Recycled plastic



In 2021 we started partnership with waste management company PreZero, which close loops with PreZero Polymers. PreZero recycled granules from post-consumer plastics, i.e. plastic waste generated by private or commercial end users, as well as post-industrial waste.



# Our range

outdoor items



vehicles



summer sets

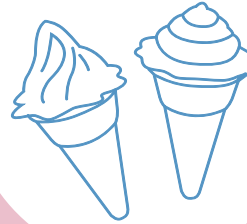

blocks

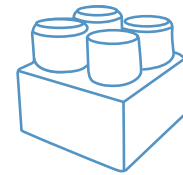

toys with bio component

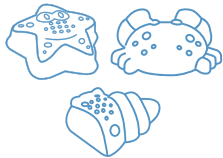

toys made of recycled plastic



indoor items

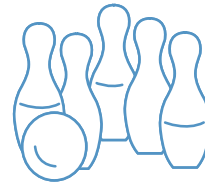

garages





# Garden





REF. 11392



REF. 10839



REF. 12243

TRADITIONAL COLORS



REF. 12793



REF. 12794



REF. 12796



REF. 12795



REF. 12795

EAN: 5907442127959

115 x 106 x 128 CM    PCB: 1 PC  
13,000 KG



REF. 12796

EAN: 5907442127966

115 x 106 x 128 CM    PCB: 1 PC  
13,000 KG

PASTEL COLORS

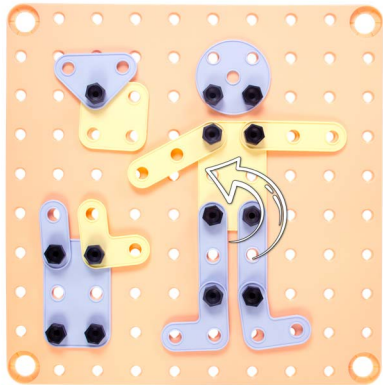

SCREW-ON GEOMETRIC BLOCKS



SLIDES FOR BALLS

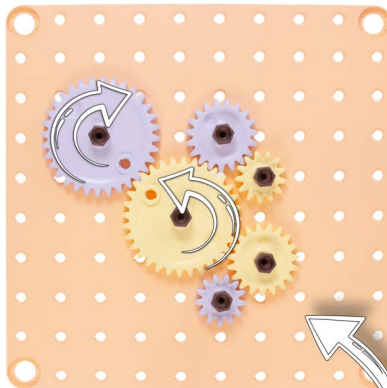

ROTATING GEARS



PINS WITH LETTERS AND NUMBERS

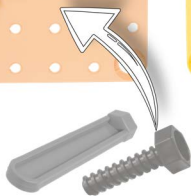

PASTEL COLORS

MOVABLE SHUTTERS

128 CM

FLOWERPOT AND CONTAINER

ROTATABLE WALLS

115 CM

106 CM



108 CM

88 CM

102 CM



PASTEL COLORS

IML

REF. 12793

EAN: 5907442127935

102 x 88 x 108 CM PCB: 1 PC  
8.650 / 9.650 KG

IML

REF. 12794

EAN: 5907442127942

102 x 88 x 108 CM PCB: 1 PC  
8.650 / 9.650 KG



REF. 11392

EAN: 5907442113921

139 x 118 x 120 CM PCB: 1 PC  
15.200 / 17.300 KG



REF. 13010

EAN: 5907442130102

175 x 120 x 120,5 CM PCB: 1 PC  
15.200 / 17.500 KG



REF. 13009

EAN: 5907442130096

122 x 120 x 120,5 CM PCB: 1 PC  
15.200 / 17.500 KG

SAND COLLECTION



**Garden House**



TRADITIONAL COLORS

BESTSELLER

REF. 10839

EAN: 5907442108392

163 x 120 x 120,5 CM PCB: 1 PC  
17,380 / 19,680 KG

**Garden  
House**

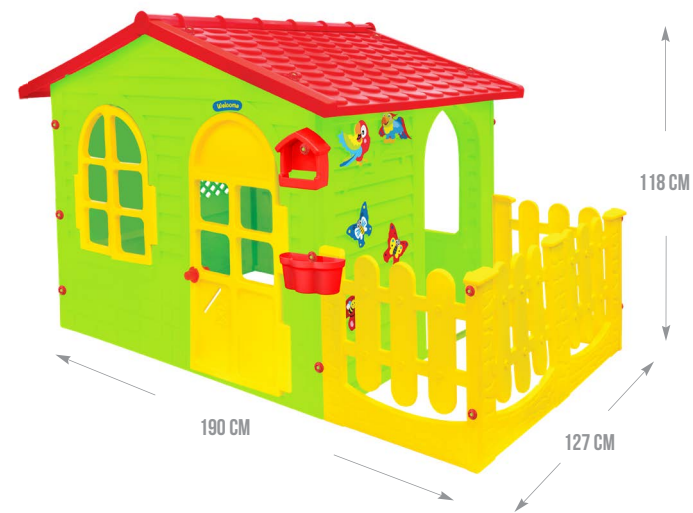

IML

REF. 12243

EAN: 5907442122435



190 x 127 x 118 CM  
18,780 / 21,380 KG

PCB: 1 PC



REF. 12768

EAN: 5907442127683

45,5 x 19 x 32 CM PCB: 1 PC  
0,300 KG



REF. 12543

EAN: 5907442125436

45,5 x 19 x 32 CM PCB: 1 PC  
0,300 KG



REF. 12769

EAN: 5907442127690

45,5 x 19 x 32 CM PCB: 1 PC  
0,300 KG

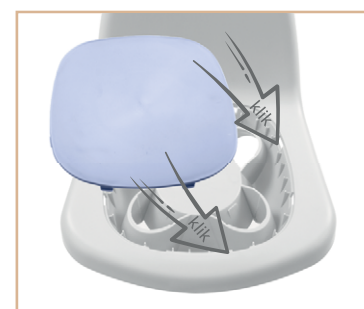
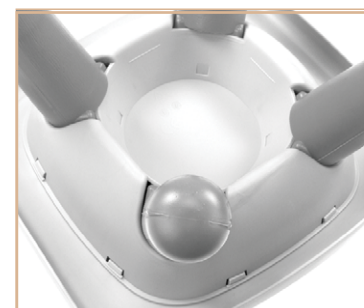
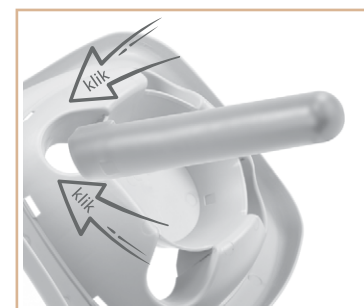



REF. 12771

EAN: 5907442127713

31,5 x 13,5 x 31,5 CM PCB: 1 PC  
0,180 KG



REF. 12544

EAN: 5907442125443

31,5 x 13,5 x 31,5 CM PCB: 1 PC  
0,180 KG



REF. 12770

EAN: 5907442127706

31,5 x 13,5 x 31,5 CM PCB: 1 PC  
0,180 KG

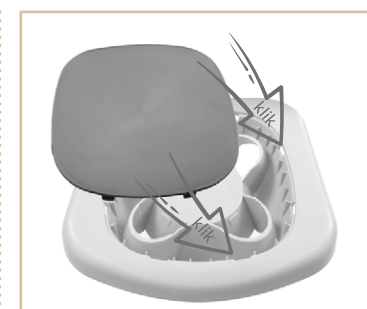
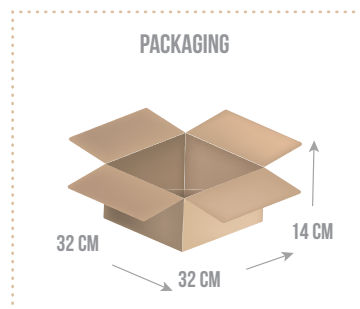
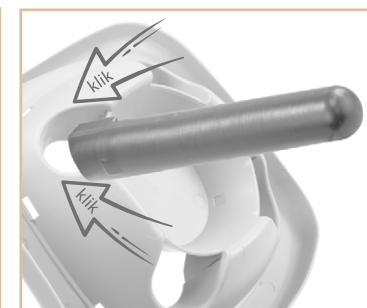



REF. 12545

EAN: 5907442125450

76 x 44 x 53 CM PCB: 1 PC  
5,472 KG

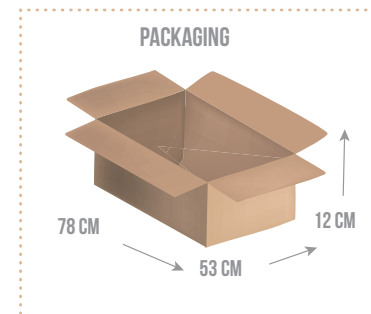
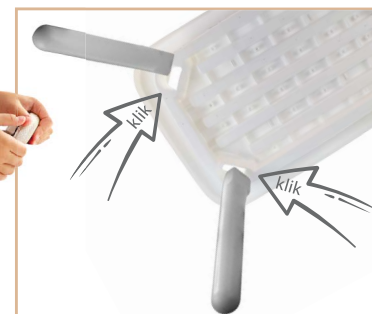
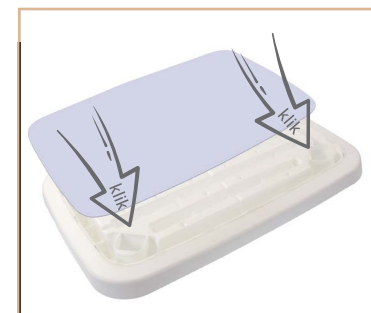

PASTEL COLORS



REF. 12923

EAN: 5907442129236

74 x 48 x 44 CM PCB: 1 PC  
3,360 KG



REF. 12950

EAN: 5907442129502

76 x 44 x 53 CM PCB: 1 PC  
5,472 KG

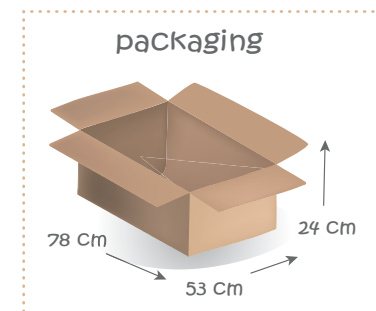
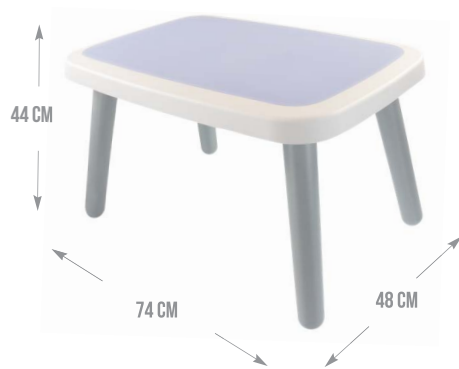

REF. 12918

EAN: 5907442129182

53 x 24 x 78 CM PCB: 1 PC  
5.400 KG

REF. 12924

EAN: 5907442129243

53 x 24 x 78 CM PCB: 1 PC  
5.400 KG



REF. 11575

EAN: 5907442115758

78 x 95 x 20 CM PCB: 1 PC  
1,540 KG

REF. 11563

EAN: 5907442115635

78 x 95 x 20 CM PCB: 1 PC  
1,460 KG



REF. 12803

EAN: 5907442128031

108 x 61 x 42 CM PCB: 1 PC  
2,450 KG

REF. 12802

EAN: 5907442128024

108 x 61 x 42 CM PCB: 1 PC  
2,450 KG



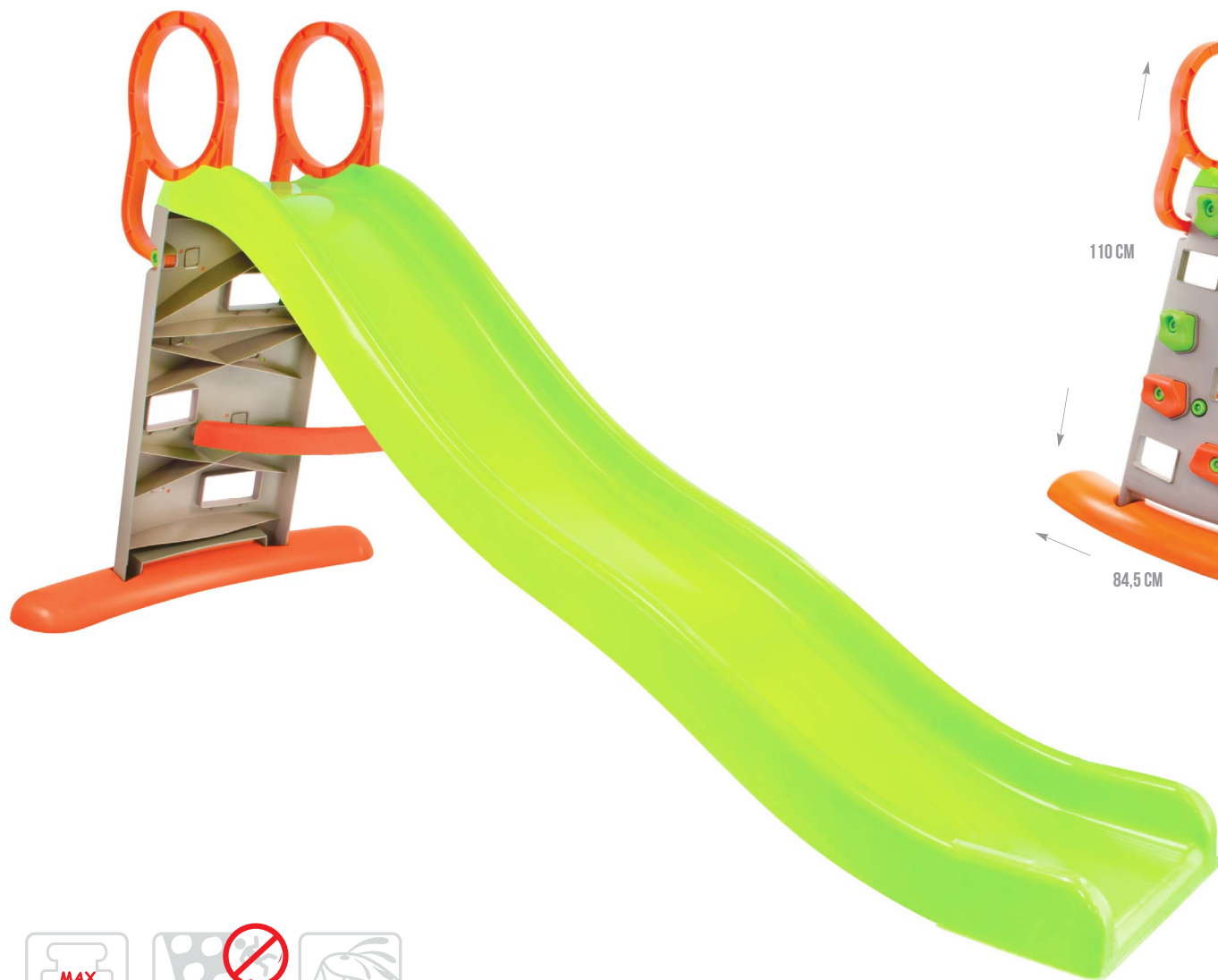

REF. 12602

EAN: 5907442126020

198 x 84 x 110 CM    PCB: 1 PC  
6.600 / 8.360 KG

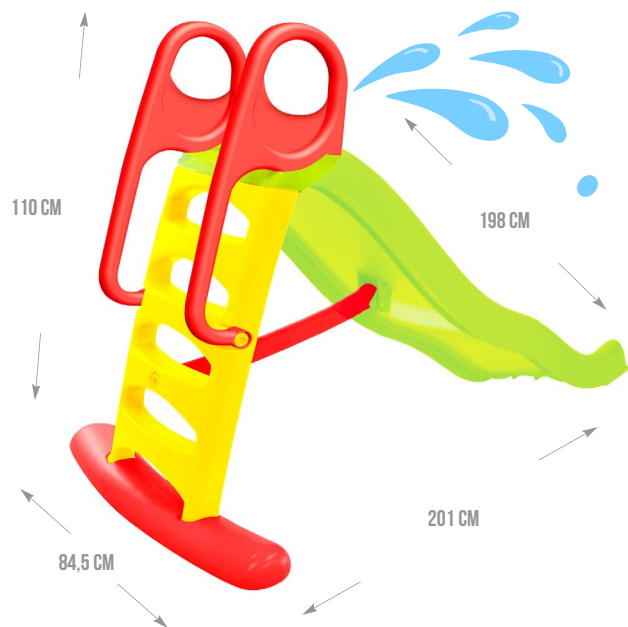

REF. 12601

EAN: 5907442126013

198 x 84 x 110 CM PCB: 1 PC  
6,000 / 7,860 KG





REF. 13012

EAN: 5907442130201

198 x 84 x 110 CM    PCB: 1 PC  
6,000 / 7,860 KG

SAND COLLECTION



TRADITIONAL COLORS



REF. 12603

EAN: 5907442126037

180 x 84 x 110 CM PCB: 1 PC  
6,200 / 7,800 KG



REF. 12799

EAN: 5907442127997

180 x 84 x 110 CM    PCB: 1 PC  
6,200 / 7,800 KG



REF. 12800

EAN: 5907442128000

180 x 84 x 110 CM    PCB: 1 PC  
6,200 / 7,800 KG



REF. 13025

EAN: 5907442130256

180 x 84 x 110 CM    PCB: 1 PC  
6,200 / 7,800 KG

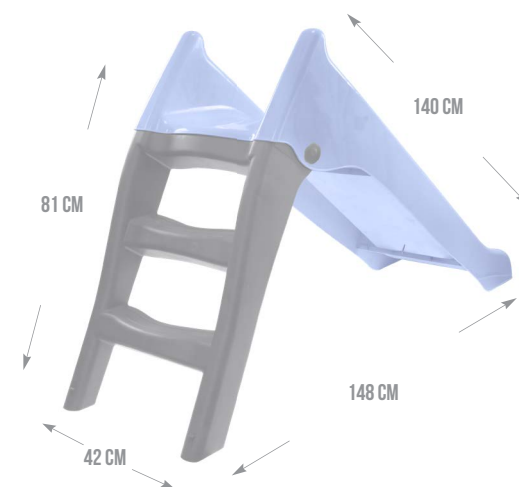

IML

REF. 12797

EAN: 5907442127973

148 x 43 x 81 CM PCB: 1 PC  
3,500 / 5,100 KG

IML

REF. 12798

EAN: 5907442127980

148 x 43 x 81 CM PCB: 1 PC  
3,500 / 5,100 KG





MIX

BEST PRICE

REF. 12801

EAN: 5907442128017

123 x 36 x 62,5 CM PCB: 1 PC  
2,130 / 2,970 KG

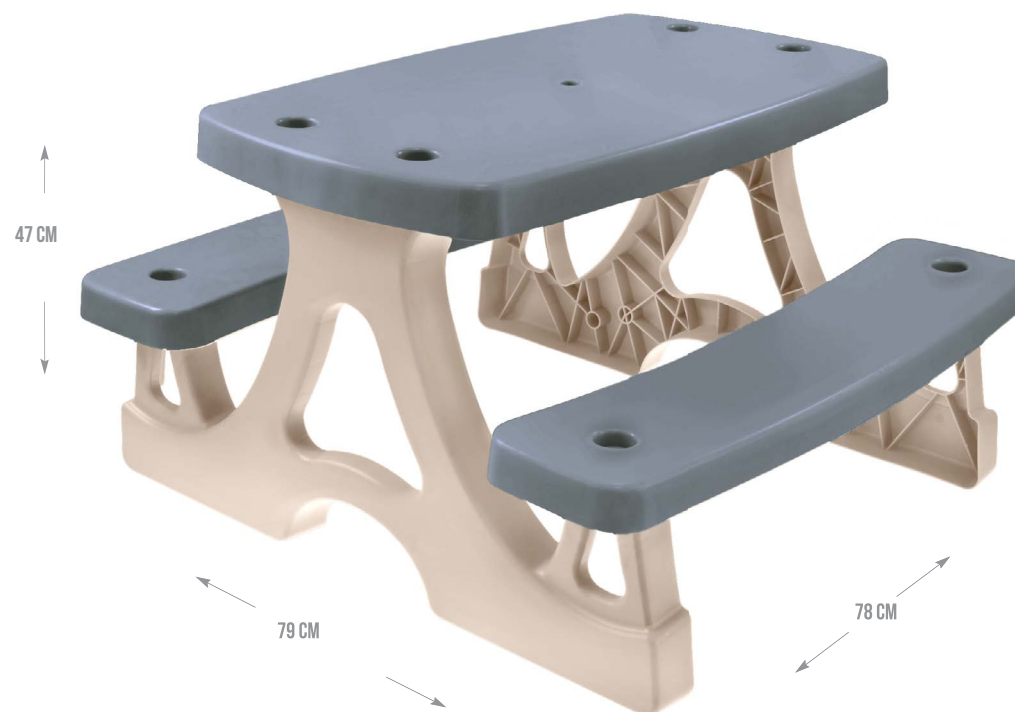

REF. 13011

EAN: 5907442130119

79 x 78 x 47 CM    PCB: 1 PC  
4,700 / 5,700 KG

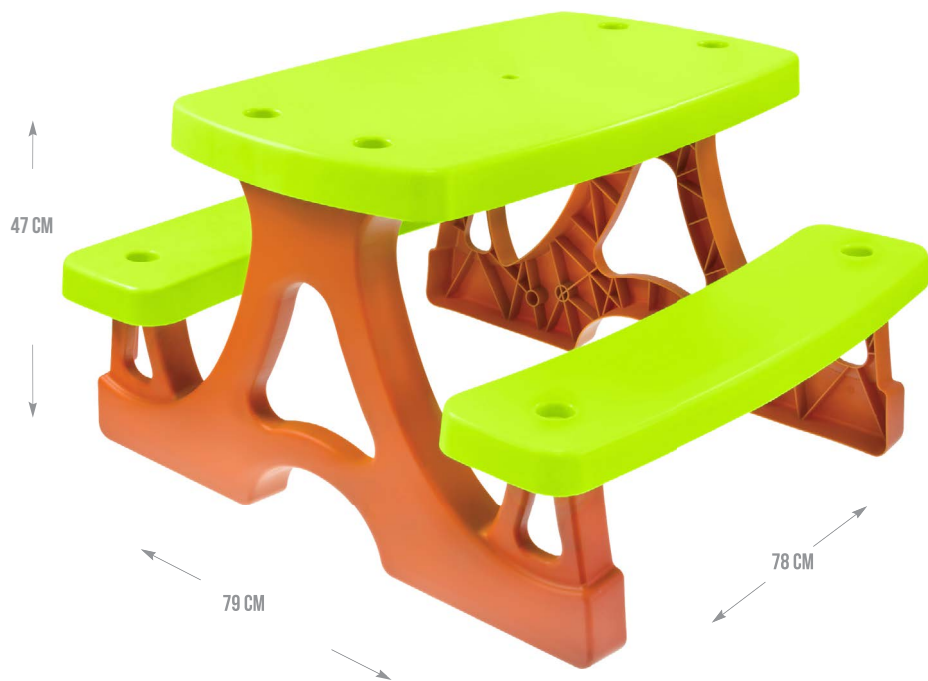

47 CM

79 CM

78 CM



REF. 10722

EAN: 5907442107227

79 x 78 x 47 CM PCB: 1 PC  
4,700 / 5,700 KG



51 CM

36 CM

32  
pcs



BESTSELLER

REF. 11021

EAN: 5907442110210

51 x 39 x 41 CM PCB: 8 PCS  
1,000 / 1,400 KG

TRADITIONAL COLORS

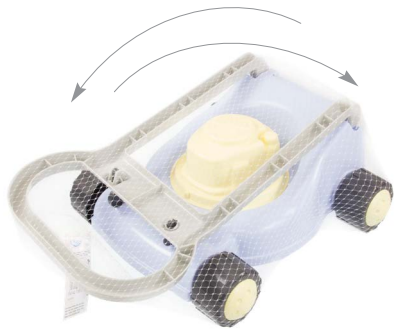

BESTSELLER

REF. 10631

EAN: 5907442106312

54 x 36 x 56 CM PCB: 8 PCS  
0.614 / 0.620 KG



PASTEL COLORS



REF. 12613

EAN: 5907442126136

32 x 16 x 200 CM PCB: 8 PCS  
0.585 KG

PASTEL COLORS



IML

REF. 12604

EAN: 5907442126044

39 x 33,5 x 33,5 CM PCB: 5 PCS  
1,126 KG



IML

REF. 12606

EAN: 5907442126068

39 x 33,5 x 33,5 CM PCB: 5 PCS  
1,126 KG



REF. 12625

EAN: 5907442126259

39 x 33,5 x 33,5 CM PCB: 5 PCS  
1,126 KG

TRADITIONAL COLORS



REF. 12612

EAN: 5907442126129

42,5 x 16,5 x 5,5 CM PCB: 8 PCS  
0,624 / 0,628 KG



REF. 12668

EAN: 5907442126686

30,5 x 30,5 x 2 CM PCB: 8 PCS  
0,520 / 0,530 KG



REF. 12812

EAN: 5907442128123

33 x 32,5 x 28 CM PCB: 20 PCS  
0,798 KG



PASTEL COLORS



REF. 12609

EAN: 5907442126099

33 x 32,5 x 28 CM PCB: 20 PCS  
0,798 KG



BESTSELLER

REF. 12872

EAN: 5907442128727

60 x 30 x 42 CM PCB: 4 PCS  
1,150 KG



MIX

REF. 10199

BESTSELLER

REF. 12871

EAN: 5907442128710

60 x 30 x 42 CM PCB: 4 PCS  
1,150 KG





COLOR  
OPTION

IML

REF. 10239

EAN: 5907442102390

57,2 x 8 x 57,2CM PCB: 12 PCS  
0,607 KG

44 CM



COLOR  
OPTION

IML

REF. 10334

EAN: 5907442103342

3 x 34 x 44 CM PCB: 30 PCS  
0,200 KG

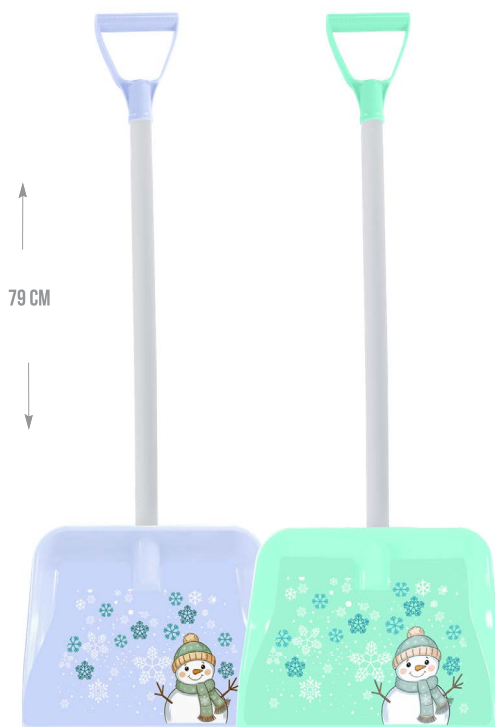

79 CM

IML

REF. 10194

EAN: 5907442101942

5 x 28 x 79 CM PCB: 12 PCS  
0,266 KG



79.5 CM

REF. 10279

EAN: 5907442102796

79,5 x 36 x 24 CM PCB: 4 PCS  
1,282 KG





IML

REF. 12781

EAN: 5907442127812

148 x 43 x 81 CM PCB: 1 PC  
3,500 / 5,100 KG

IML

REF. 12782

EAN: 5907442127829

39 x 33,5 x 33,5 CM PCB: 5 PCS  
1,126 KG

\* FOR DISTRIBUTION IN FOLLOWING COUNTRIES ONLY: AT, BE, NL, BG, HR, CZ, D, HU, IT, LV, LT, PL, RO, SE.



33,5 CM



BML

REF. 12819

EAN: 5907442127829

36 x 14 x 27,5 CM  
1,126 KG

PCB: 8 PCS

IML

REF. 12790

EAN: 5907442127904

102 x 88 x 108 CM  
8,650 / 9,650 KG

PCB: 1 PCS



\* FOR DISTRIBUTION IN FOLLOWING COUNTRIES ONLY: AT, BE, NL, BG, HR, CZ, D, HU, IT, LV, LT, PL, RO, SE.

# Summer sets





# foldable Beach playset





REF. 12441  2.6 L  
 EAN: 5907442124415  
 20 x 8 x 24 CM PCB: 12 PCS  
 0.207 KG







REF. 12752  2.6 L  
 EAN: 5907442127522  
 23 x 15 x 29 CM PCB: 12 PCS  
 0.396 KG

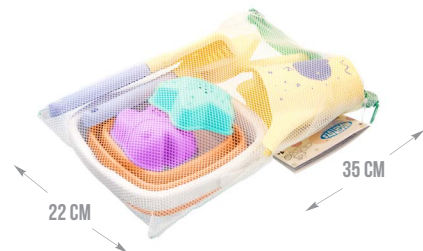



REF. 12500  2.6 L  
 EAN: 5907442125009  
 23 x 15 x 29 CM PCB: 12 PCS  
 0.345 / 0.360 KG





REF. 12581  2.6 L  
 EAN: 5907442125818  
 22 x 21,5 x 21,5 CM PCB: 60 PCS  
 0.281 / 0.291 KG

REF. 12582   
 EAN: 5907442125825  
 17 x 16 x 24,5 CM PCB: 25 PCS  
 0,244 / 0,245 KG



REF. 12584   
 EAN: 5907442125849  
 20 x 15,5 x 28 CM PCB: 25 PCS  
 0,252 / 0,262 KG

REF. 12583   
 EAN: 5907442125832  
 16,5 x 14,5 x 24,5 CM PCB: 25 PCS  
 0,231 / 0,241 KG

REF. 13052

EAN: 5907442130522

24 x 14 x 34 CM  
0,492 KG

PCB: 4 PCS



BESTSELLER

REF. 12783

EAN: 5907442127836

24 x 14 x 34 CM  
0,610 KG

PCB: 4 PCS

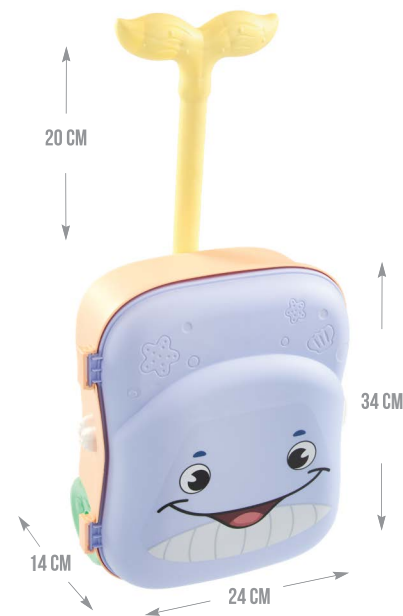



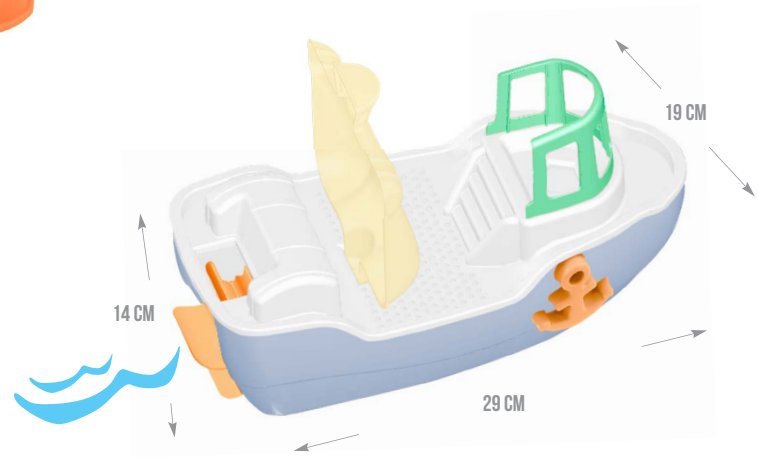

REF. 13092

EAN: 5907442130928

29 x 19 x 14 CM  
0,715 / 0,719 KG

PCB: 6 PCS

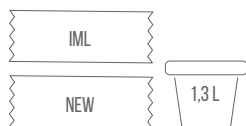

REF. 12567

EAN: 5907442125672

19 x 16,5 x 33 CM PCB: 20 PCS  
0,292 / 0,329 KG

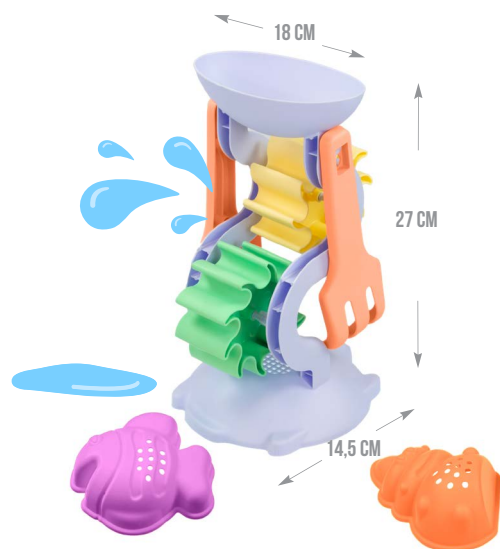

REF. 5354

EAN: 5900747003546

18 x 14,5 x 27 CM PCB: 20 PCS  
0,260 / 0,264 KG



REF. 12789

EAN: 5907442127898

12 x 13 x 23 CM PCB: 24 PCS  
0,175 KG





MIX	BESTSELLER
IML	TRANSPARENT

1,3 L

REF. 11568 \*

EAN: 5907442115680

18 x 16 x 30 CM PCB: 25 PCS  
0.220 / 0.230 KG



MIX	BESTSELLER
IML	TRANSPARENT

1,3 L

REF. 11569

EAN: 5907442115697

18 x 16 x 34 CM PCB: 20 PCS  
0.270 / 0.280 KG



BESTSELLER

MIX

IML

1,3 L

REF. 11100

EAN: 5907442111002

17 x 37,5 x 29 CM PCB: 6 PCS  
0,380 KG

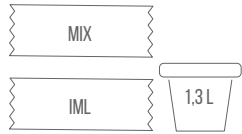

REF. 5608

EAN: 5900747006080

18 x 16,5 x 24,5 CM PCB: 30 PCS  
0,210 / 0,214 KG

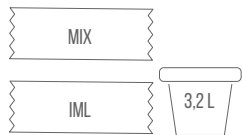

REF. 11570

EAN: 5907442115703

22,5 x 21 x 40 CM PCB: 12 PCS  
0,360 / 0,364 KG



TRANSPARENT

MIX

IML

3,2L

REF. 11199

EAN: 5907442111996

22,5 x 21 x 37 CM PCB: 12 PCS  
0,300 / 0,304 KG



TRANSPARENT

MIX

IML

3,2L

REF. 11195

EAN: 5907442111958

22,5 x 21 x 42 CM PCB: 12 PCS  
0,360 / 0,370 KG



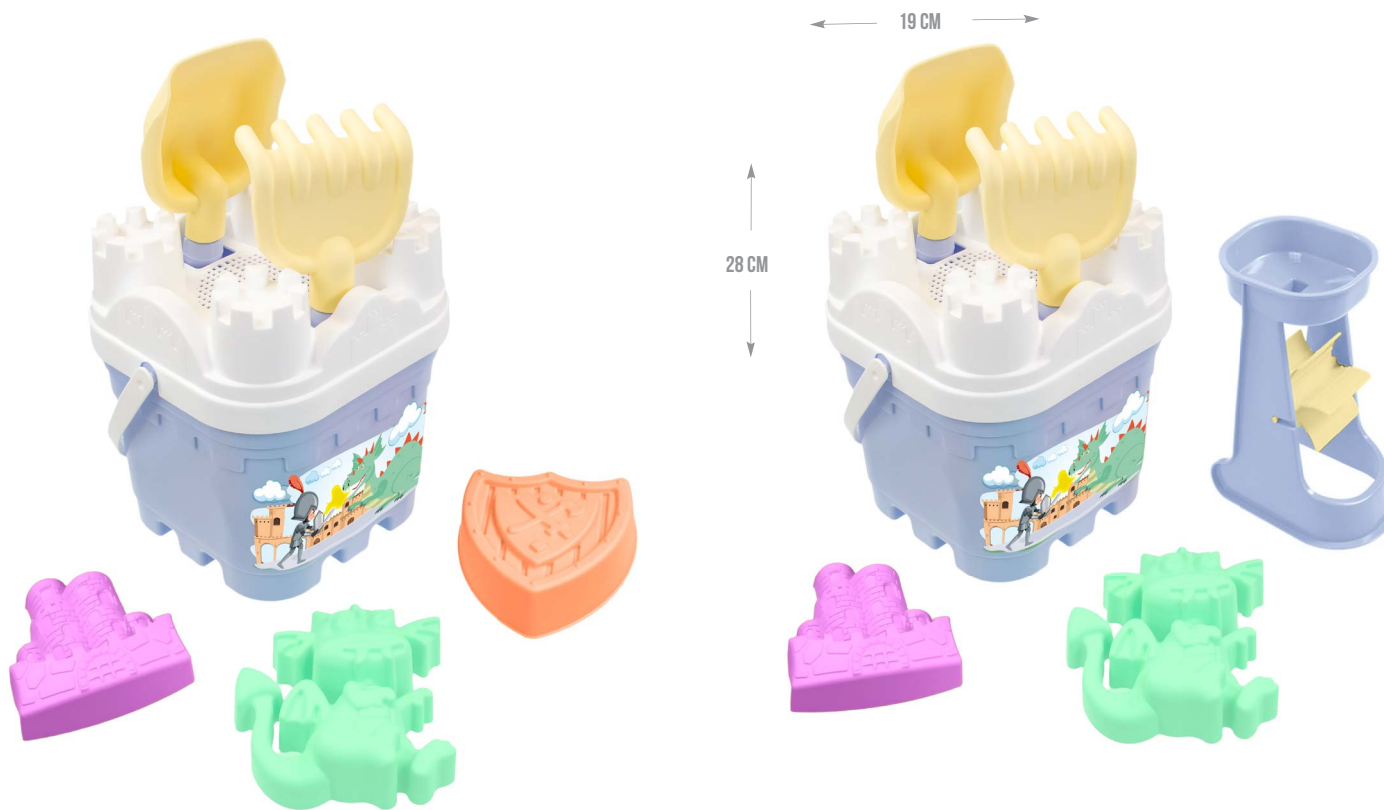

REF. 11960

EAN: 5907442119602

19 x 17,5 x 28 CM PCB: 12 PCS  
0,391 / 0,395 KG



REF. 12014

EAN: 5907442120141

19 x 17,5 x 39 CM PCB: 12 PCS  
0,451 / 0,455 KG



IML

REF. 11830

EAN: 5907442118308

19 x 7 x 26 CM PCB: 24 PCS  
0,100 / 0,150 KG



BESTSELLER

IML

1,3 L

REF. 11831

EAN: 5907442118315

18 x 16 x 29 CM PCB: 20 PCS  
0,210 / 0,214 KG



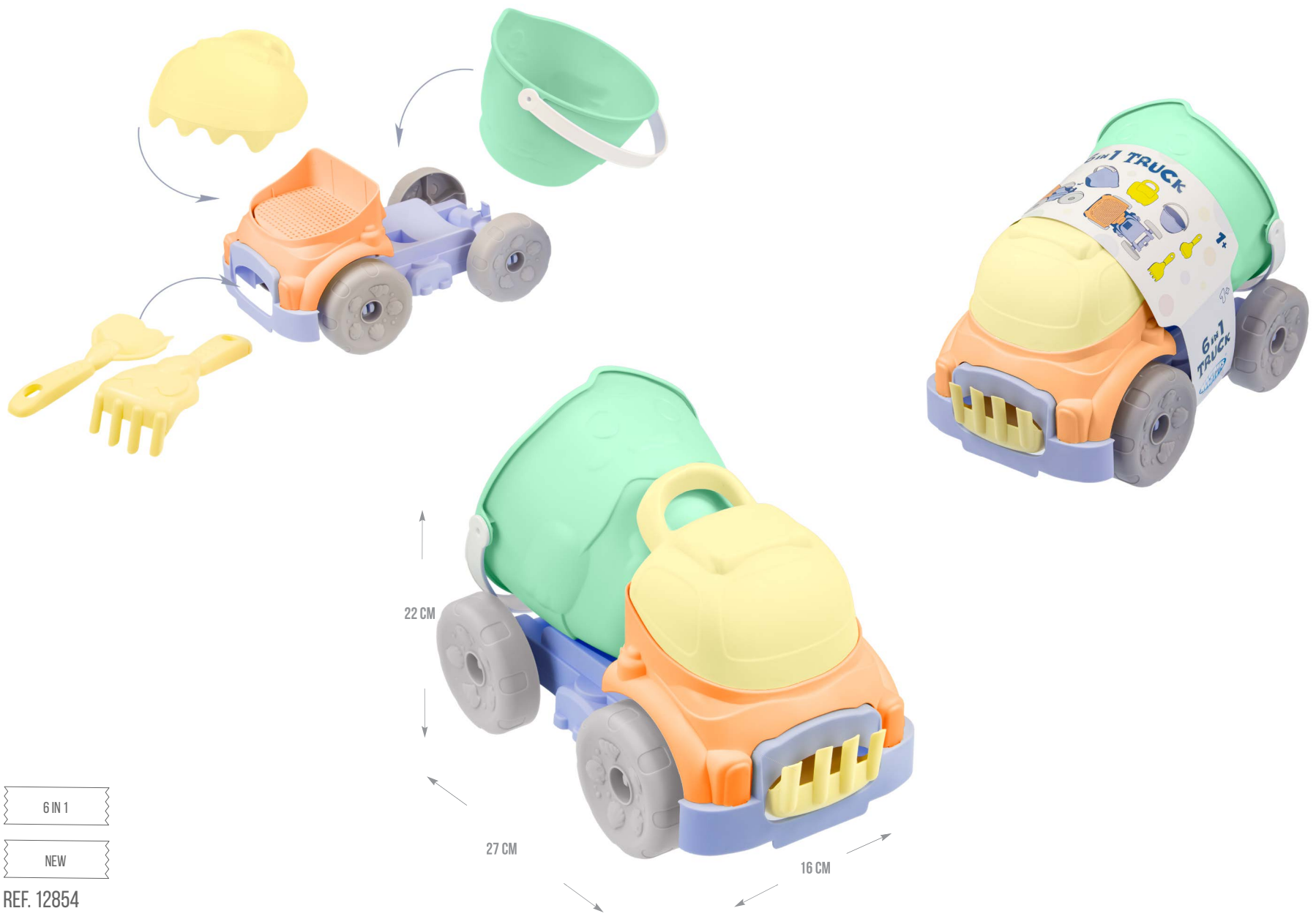

6 IN 1  
NEW

REF. 12854

EAN: 5907442128543

27 x 16 x 22 CM  
0,291 KG

PCB: 6 PCS



REF. 12785 

EAN: 5907442127850

 12 x 11 x 19 CM PCB: 24 PCS  
0,122 KG



REF. 12860 

EAN: 5907442128604

 18 x 13 x 10 CM PCB: 24 PCS  
0,108 KG



REF. 12861 

EAN: 5907442128611

 12 x 11 x 23 CM PCB: 24 PCS  
0,147 KG



REF. 12862 

EAN: 5907442128628

 32 x 17 x 23.5 CM PCB: 12 PCS  
0,295 KG

\* ALTERNATIVE COLORS



IML

REF. 12503

EAN: 5907442125030

40,5 x 24,5 X x 28 CM PCB: 4 PCS  
0,760 / 0,770 KG



BESTSELLER

IML

REF. 12198

EAN: 5907442121988

40,5 x 24,5 x 28 CM    PCB: 4 PCS  
0,760 KG



↑  
22 CM  
↓

25 CM

35 CM



68 CM

PASTEL COLORS

BESTSELLER

IML

REF. 11178

EAN: 5907442111781

68 X 25 X 22 CM    PCB: 4 PCS  
0,840 / 0,844 KG



BESTSELLER

REF. 5371

EAN: 5900747003713

66,5 x 31,5 x 27,5 CM PCB: 6 PCS  
0,942 / 0,948 KG



BESTSELLER

REF. 10278

EAN: 5907442102789

67,5 x 32 x 28,5 CM PCB: 4 PCS  
0,815 KG





NEW

REF. 12864

EAN: 5907442128642

59 x 30 x 25 CM  
0,486 KG

PCB: 4 PCS



NEW

REF. 13053

EAN: 5907442130539

59 x 30 x 28 CM  
0,522 KG

PCB: 4 PCS



NEW

REF. 13044

EAN: 5907442130447

59 x 30 x 25 CM  
0,528 KG

PCB: 4 PCS

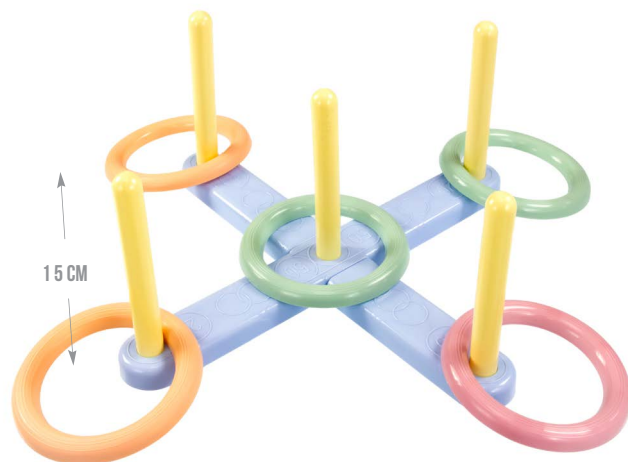

15 CM

REF. 12262

EAN: 5907442122626

38 x 38 x 15 CM PCB: 24 PCS  
0,178 / 0,182 KG

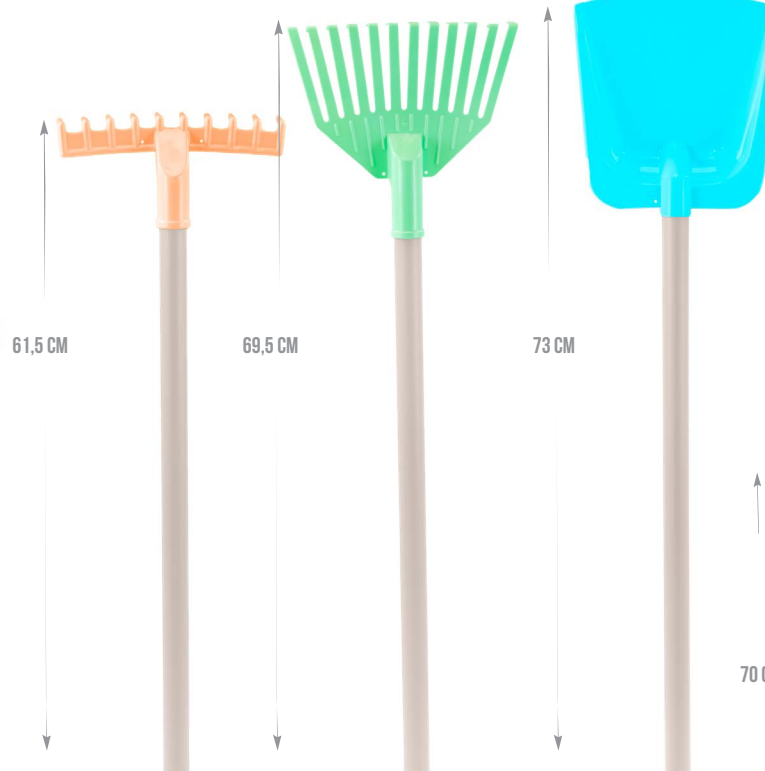

61,5 CM

69,5 CM

73 CM



70 CM

39 CM

39 CM



42,5 CM

REF. 5055

EAN: 5900747000750

42,5 x 19 x 6,5 CM PCB: 24 PCS  
0,178 / 0,184 KG

REF. 10854

EAN: 5907442126198

65,5 x 15,5 x 4 CM PCB: 24 PCS  
0,11 KG



# FUNNY HOOPS

PASTEL COLORS



mix 60 / 70 / 80 cm  
3 x 12 pcs  
81x20x81 cm; 0,128 m3  
optional display box

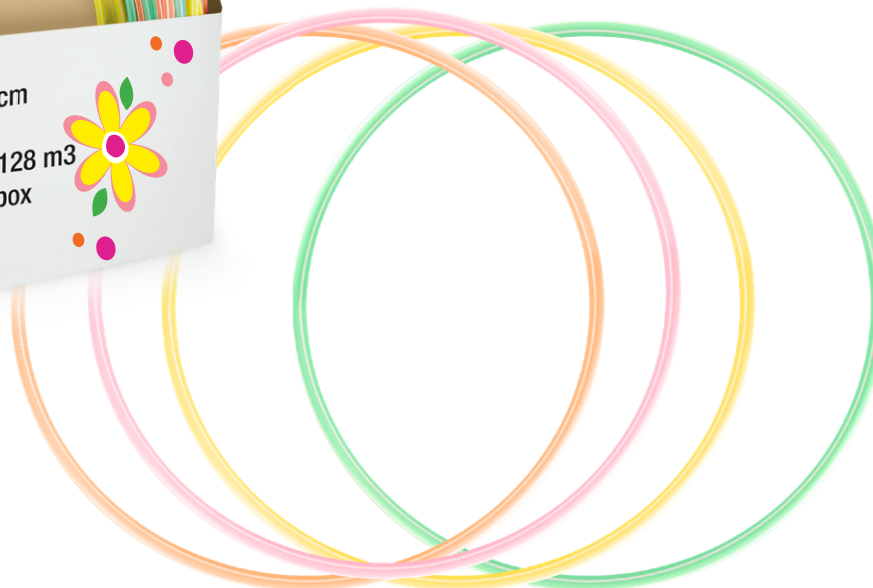

mix 60 / 70 / 80 cm  
3 x 12 pcs  
81x20x81 cm; 0,128 m3  
optional display box



REF. 10596  
EAN: 5907442105964 Ø 60 CM

60 X 60 X 1,8 CM PCB: 10 PCS  
0,114 KG

REF. 10597  
EAN: 5907442105971 Ø 70 CM

70 X 70 X 1,8 CM PCB: 10 PCS  
0,134 KG

REF. 10598  
EAN: 5907442105988 Ø 80 CM

80 X 80 X 1,8 CM PCB: 10 PCS  
0,170 KG

MIX

REF. 10890  
EAN: 5907442108903

80 X 80 X 1,8 CM PCB: 36 PCS  
0,170 KG



Ø 60 CM  
Ø 70 CM  
Ø 80 CM

MIX

REF. 10787  
EAN: 5907442107876

80X80X1,8 CM PCB: 36 PCS  
0,170 KG



REF. 13060

EAN: 5907442130607

24 x 14 x 34 CM PCB: 4 PCS  
0,610 KG



REF. 13061



EAN: 5907442130614

12 x 11 x 19 CM PCB: 24 PCS  
0,122 KG



REF. 13058

EAN: 5907442130584

18 x 14,5 x 27 CM PCB: 20 PCS  
0,260 / 0,264 KG



REF. 13054

EAN: 5907442130546

20 x 15,5 x 28 CM PCB: 25 PCS  
0,252 / 0,262 KG

TRADITIONAL COLORS



REF. 13055

EAN: 5907442130553

18 x 16 x 29 CM PCB: 20 PCS  
0,210 / 0,214 KG



REF. 13056

EAN: 5907442130560

19 x 17,5 x 28 CM PCB: 12 PCS  
0,391 / 0,395 KG



REF. 13057

EAN: 5907442130577

18 x 16,5 x 24,5 CM PCB: 25 PCS  
0,210 KG





REF. 13059

EAN: 5907442130591

24 x 14 x 34 CM PCB: 4 PCS  
0.610 KG

# Toys with bio component



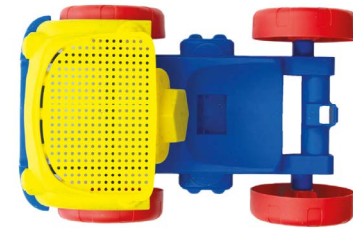
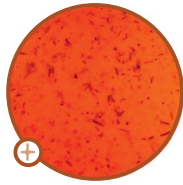

REF. 12658

EAN: 5907442126587

27 x 16 x 22 CM PCB: 6 PCS  
0,291 / 0,311 KG

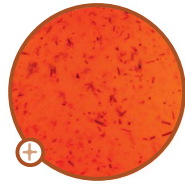

REF. 12620



EAN: 5907442126204

12 x 11 x 23 CM PCB: 24 PCS  
0,147 / 0,156 KG



REF. 12615



EAN: 5907442126150

12 x 11 x 19 CM PCB: 24 PCS  
0,122 / 0,132 KG



REF. 12621



EAN: 5907442126211

32 x 17 x 23,5 CM PCB: 12 PCS  
0,295 / 0,395 KG



REF. 12619

EAN: 5907442126198

18 x 13 x 10 CM PCB: 24 PCS  
0,108 / 0,118 KG

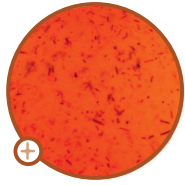

REF. 12645

EAN: 5907442126457

37 x 17 x 22 CM PCB: 4 PCS  
0.785 KG



# Eco friendly toys



MADE OF 100% RECYCLED MATERIAL

## Cooperation with PreZero

In 2021 we started partnership with waste management company PreZero, which close loops with PreZero Polymers. They provide recycled granules from post-consumer plastics, i.e. plastic waste generated by private or commercial end users, as well as post-industrial waste.

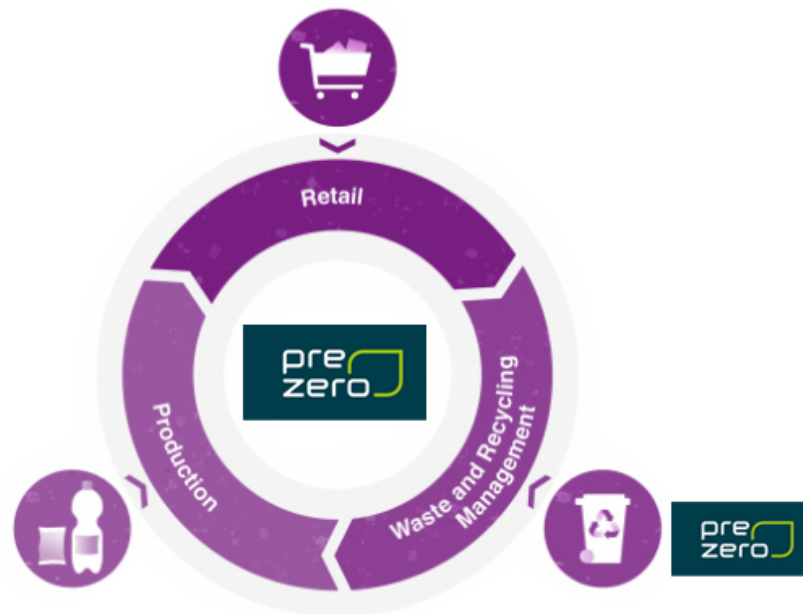

The key to the closed loop: From production to retail and all the way to waste removal and recycling.



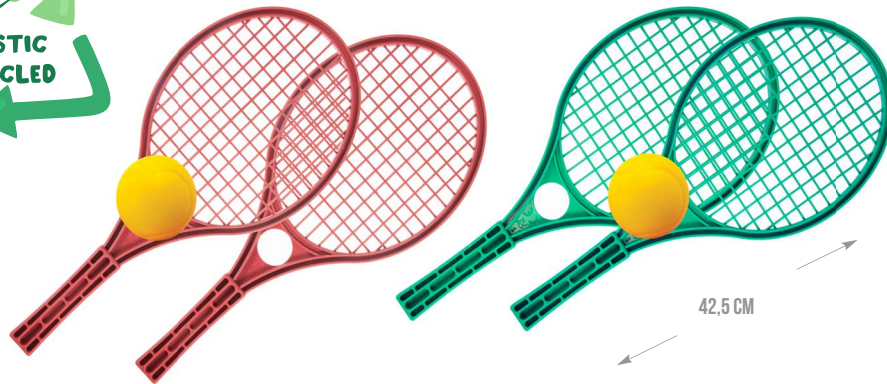

REF. 12450

EAN: 5907442124507

42,5 x 19 x 6,5 CM PCB: 24 PCS  
0,178 / 0,184 KG



REF. 12449

EAN: 5907442124491

68 X 25 X 22 CM PCB: 4 PCS  
0,840 / 0,844 KG



REF. 12452

EAN: 5907442124521

31 x 17 x 18 CM PCB: 6 PCS  
0,358 / 0,526 KG



REF. 12448

EAN: 5907442124484

18 x 16 x 34 CM PCB: 20 PCS  
0,270 / 0,280 KG



MADE OF 100% RECYCLED MATERIAL

RECYCLED COLORS



REF. 12736 \*

EAN: 5907442127362

37 x 19,5 x 22 CM PCB: 6 PCS  
0,632 KG

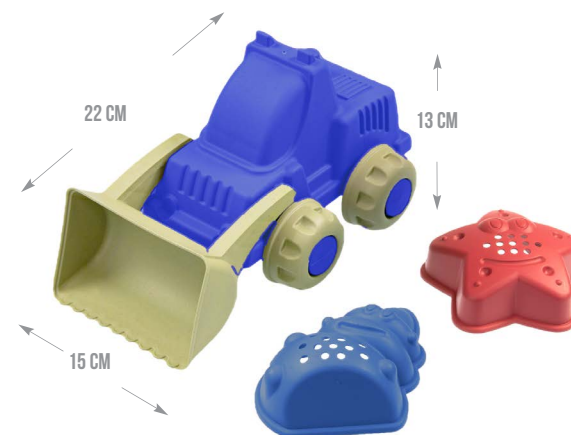

REF. 12743 \*

EAN: 5907442127430

37 x 17 x 22 CM PCB: 8 PCS  
0,785 KG

REF. 12927 \*

EAN: 5907442129274

22 X 15 x 13 CM PCB: 12 PCS  
0,164 KG

MADE OF 100% RECYCLED MATERIAL

RECYCLED COLORS



REF. 12926

EAN: 5907442129267

13 x 12 x 17 CM  
0,131 KG

PCB: 16 PCS



REF. 12841

EAN: 5907442128413

17 x 15 x 26,5 CM  
0,292 KG

PCB: 20 PCS

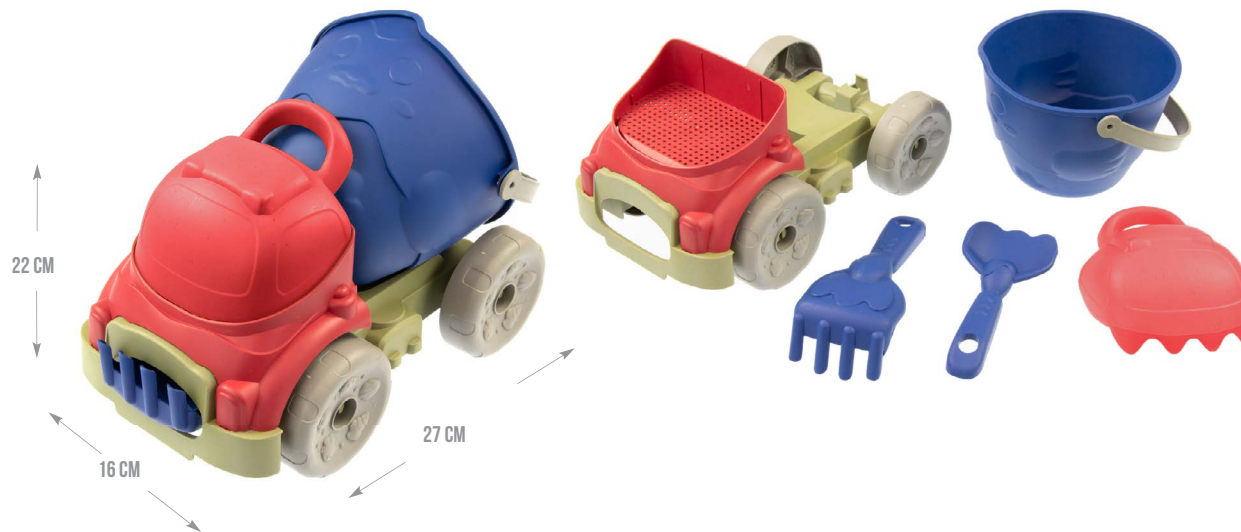

REF. 12741

EAN: 5907442127416

27 x 16 x 22 CM  
0,313 KG

PCB: 6 PCS

MADE OF 100% RECYCLED MATERIAL

RECYCLED COLORS

# Vehicles





REF. 11897

EAN: 5907442118971

17 X 37 x 22 CM PCB: 6 PCS  
0,764 KG

REF. 12497

EAN: 5907442124972

33 x 17 x 23 CM PCB: 6 PCS  
0,700 KG



REF. 11895

EAN: 5907442118957

17 x 37 x 25 CM PCB: 6 PCS  
0,979 KG

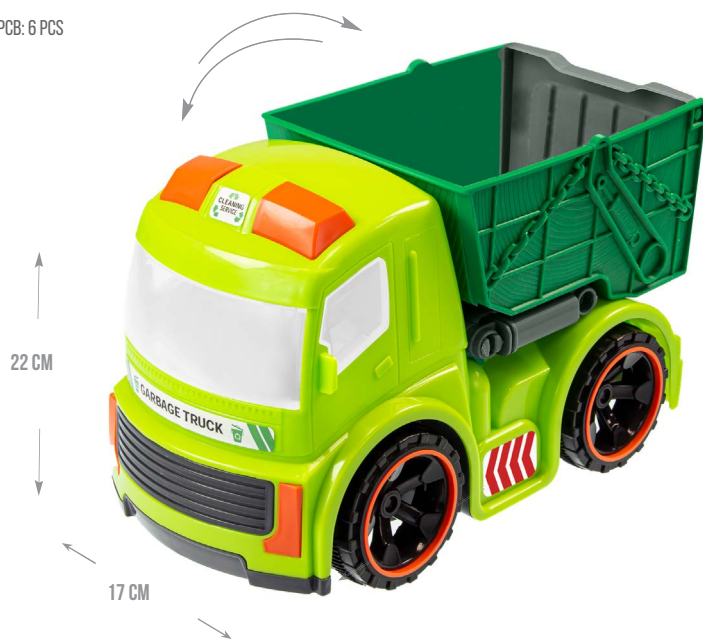

NEW

REF. 12600

EAN: 5907442126006

17 x 37 x 22 CM PCB: 6 PCS  
0,910 KG



REF. 11896

EAN: 5907442118964

17 x 37 x 22 CM PCB: 6 PCS  
0,901 KG





REF. 12541

EAN: 5907442125412

22 x 12 x 13 CM PCB: 12 PCS  
0,117 KG

# Sensory toys





PASTEL COLORS



24 PCS + TRAIN

NEW

REF. 12774

EAN: 5907442127744

38 x 10,5 x 19 CM PCB: 6 PCS  
0,623 KG

12 PCS + TRAIN

NEW

REF. 12775

EAN: 5907442127751

38 x 10,5 x 19 CM PCB: 6 PCS  
0,520 KG

# PLAY & SQUISH



12 PCS + TRAIN

NEW

REF. 12776

EAN: 5907442127768

31,5 x 12,5 x 23 CM PCB: 6 PCS  
0,617 KG

24 PCS + 4 MATS

NEW

REF. 12777

EAN: 5907442127775

39 x 8,2 x 29 CM PCB: 6 PCS  
0,808 KG

PASTEL COLORS

# PLAY & SQUISH

PASTEL COLORS



18 CM



24 PCS

4 CIRCLES + 4 MATS

NEW

REF. 12778

EAN: 5907442127768

31,5 x 12,5 x 23 CM PCB: 6 PCS  
0,617 KG

8 CIRCLES

NEW

REF. 12780

EAN: 5907442127805

39 x 8,2 x 29 CM PCB: 4 PCS  
0,0418 KG

# PLAY & SQUISH

PASTEL COLORS



29 CM



14 CM

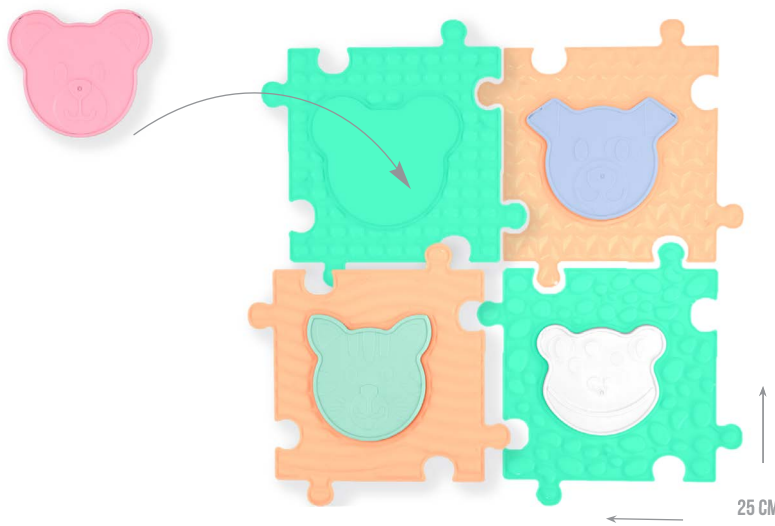

25 CM

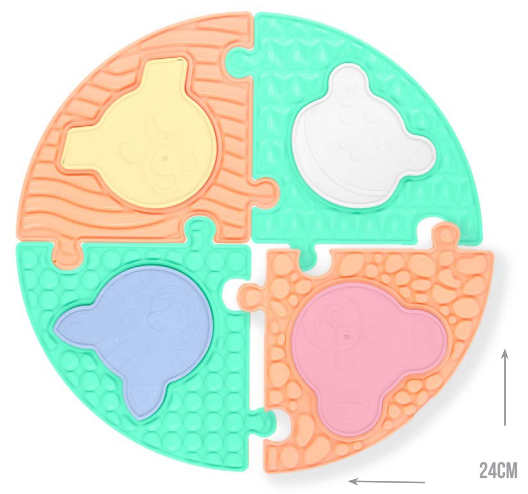

24 CM

4 CIRCLES + 16 PUZZLES

NEW

REF. 12938

EAN: 5907442129380

29 x 3,5 x 28,5 CM PCB: 4 PCS  
0,668 KG

# PLAY & SQUISH



PASTEL COLORS

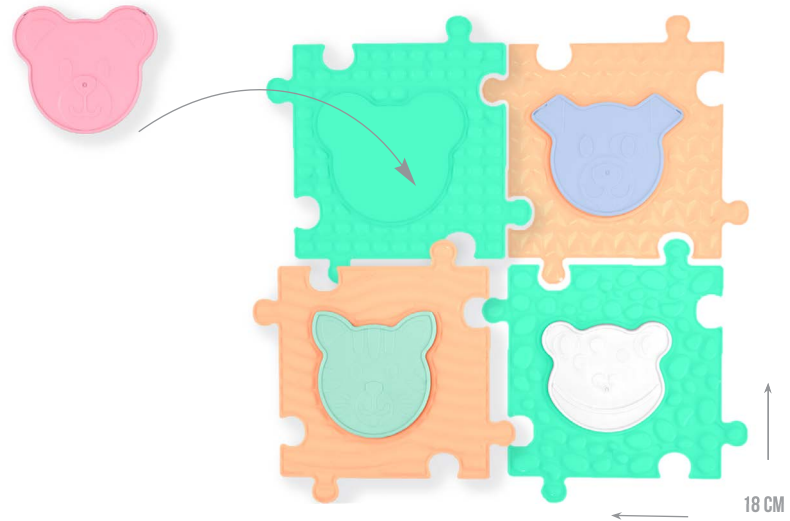
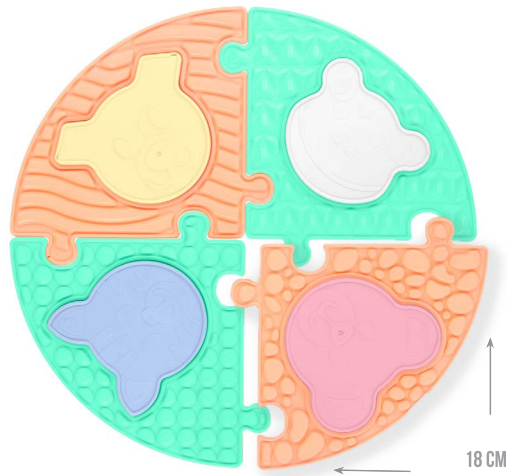

12 PCS

4 MATS + 16 PUZZLES

NEW

REF. 12939

EAN: 5907442129397

39 x 8,2 x 29 CM  
0,850 KG

PCB: 6 PCS

# PLAY & SQUISH



PASTEL COLORS



24 PCS

NEW

REF. 12773

EAN: 5907442127737

19 x 11 x 25 CM PCB: 6 PCS  
0,415 KG

24 PCS

NEW

REF. 12779

EAN: 5907442127799

19 x 11 x 25 CM PCB: 6 PCS  
0,415 KG



# Mini PLAY & SQUISH

SQUISH



SQUISH



52 MM



PASTEL COLORS

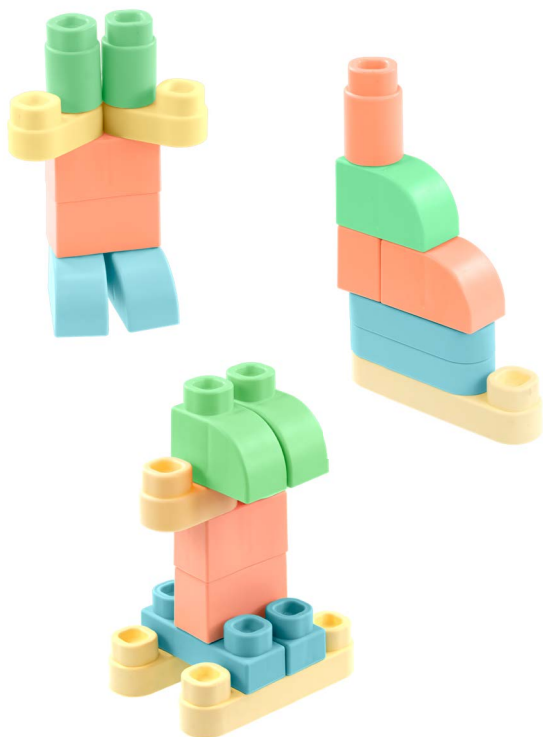

52 PCS

NEW

REF. 12910

EAN: 5907442129106

19 x 11 x 38,5 CM PCB: 6 PCS  
0,998 KG

28 PCS

NEW

REF. 12911

EAN: 5907442129113

19 x 11 x 25 CM PCB: 6 PCS  
0,544KG

# Blocks



# Grid Blocks

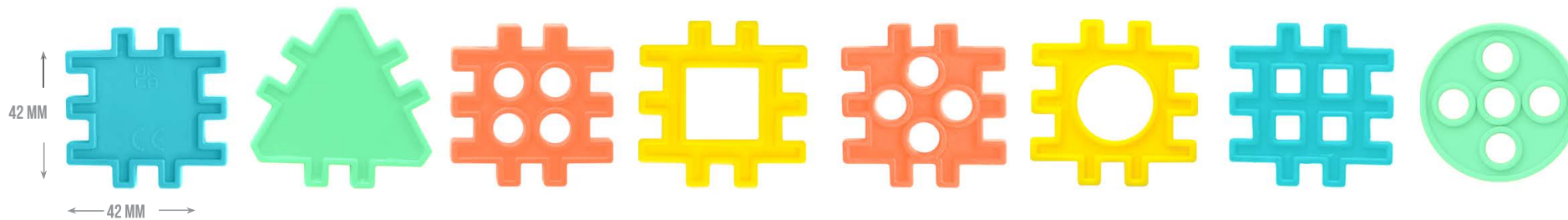

PASTEL COLORS

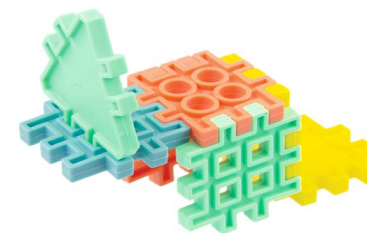
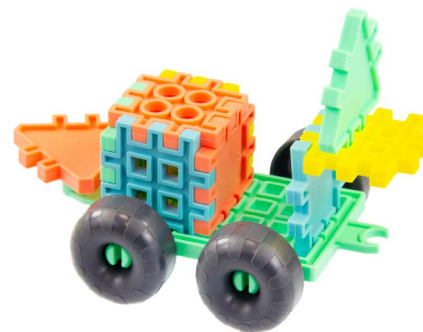

120 PCS

NEW

REF. 12334

EAN: 5907442123340

16 x 5 x 24 CM    PCB: 15 PCS  
0,480 KG

# Grid Blocks



200 PCS

NEW

REF. 12335

EAN: 5907442123357

16 x 13 x 23,5 CM PCB: 6 PCS  
0,754 KG



100 PCS

NEW

REF. 12325

EAN: 5907442123258

14 x 13 x 17,3 CM PCB: 12 PCS  
0,095 KG



50 PCS

NEW

REF. 12333

EAN: 5907442123333

10 x 10 x 15 CM PCB: 6 PCS  
0,215 KG



PASTEL COLORS

**bloko**



154 PCS

IML

REF. 12348 \*

EAN: 5907442123487

37 x 14 x 23 CM PCB: 6 PCS  
1,162 / 1,446 KG



100 PCS

IML

BESTSELLER

REF. 12366 \*

EAN: 5907442123661

23 x 21 x 23 CM PCB: 6 PCS  
1,185 KG



60 PCS

3D

REF. 12143\*

EAN: 5907442121438

29 x 5,5 x 29 CM PCB: 12 PCS  
0,440 / 0,613 KG



100 PCS

REF. 12548

EAN: 5907442125481

39 x 5,5 x 29 CM PCB: 8 PCS  
0,725 KG



\* FOR DISTRIBUTION IN FOLLOWING COUNTRIES ONLY: AT, BG, HR, CY, CZ, D, EE, FI, D, GR, HU, LV, LT, MT, NL, PL, RO, SK, SO, SE, CH, RU, TR, UA

STANDARD COLORS

BLOCKS

**bloko**



50 PCS

BESTSELLER

REF. 12132 \*

EAN: 5907442121322

15 x 15 x 14,5 CM PCB: 10 PCS  
0,368 KG

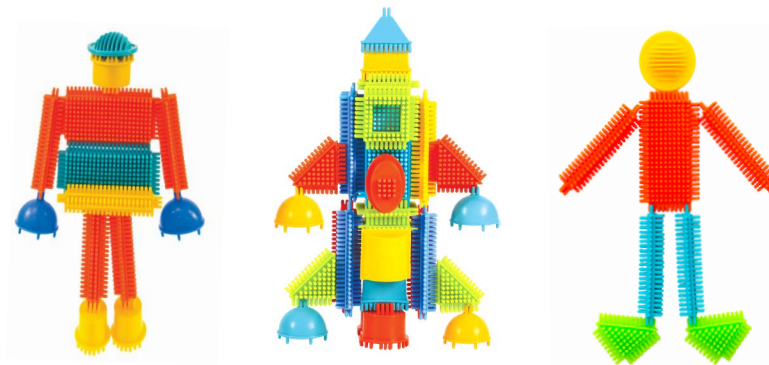

75 PCS

REF. 11600 \*

EAN: 5907442116007

15 x 15 x 22 CM PCB: 12 PCS  
0,516 KG



100 PCS

REF. 12151 \*

EAN: 5907442121513

15 x 15 x 30 CM PCB: 6 PCS  
0,790 KG



30 PCS

REF. 12412

EAN: 5907442124125

10,5 x 10,5 x 12 CM PCB: 9 PCS  
0,225 KG

\* FOR DISTRIBUTION IN FOLLOWING COUNTRIES ONLY: AT, BG, HR, CY, CZ, D, EE, FI, D, GR, HU, LV, LT, MT, NL, PL, RO, SK, SO, SE, CH, RU, TR, UA

**bloko**

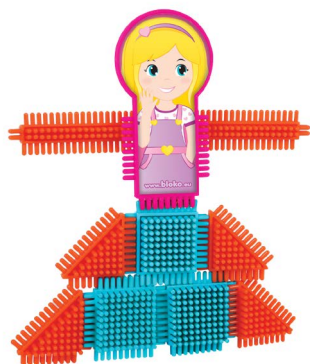

STANDARD COLORS

200 PCS

REF. 12813 \*

EAN:5907442128130

25 x 11 x 29 CM PCB: 6 PCS  
0,790 KG

100 PCS

REF. 12202 \*

EAN: 5907442122022

7 x 7 x 100 CM PCB: 12 PCS  
0,844 KG

\* FOR DISTRIBUTION IN FOLLOWING COUNTRIES ONLY: AT, BG, HR, CY, CZ, D, EE, FI, D, GR, HU, LV, LT, MT, NL, PL, RO, SK, SO, SE, CH, RU, TR, UA

**Combi**  
BLOCKS

29 MM

90 MM

PASTEL COLORS



100 PCS

REF. 0102  
EAN: 5900747001023

17 X 13 X 28 CM  
0,550 KG PCB: 24 PCS

150 PCS

REF. 0117  
EAN: 5900747001047

25 X 16 X 30 CM  
0,820 KG PCB: 15 PCS

200 PCS

REF. 0103  
EAN: 5900747001030

22 X 15 X 37 CM  
1,120 KG PCB: 12 PCS



# Combined sets



# The Castle of the King



\* FOR DISTRIBUTION IN FOLLOWING COUNTRIES: AT, BG, HR, CY, CZ, D, EE, FI, D, GR, HU, LV, LT, MT, NL, PL, RO, SK, SO, SE, CH, RU, TR, UA



BESTSELLER

REF. 11073 \*

EAN: 5907442110739

38 x 39 x 24,5 CM PCB: 4 PCS  
1,100 / 1,510 KG

# Car garage

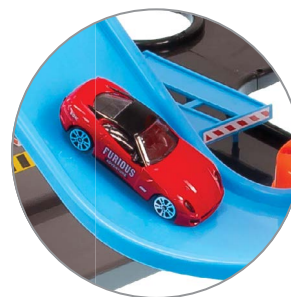

REF. 11609

EAN: 5907442116090

113 x 82 x 30,5 CM PCB: 4 PCS  
2,500 / 3,100 KG

# Car garage MEGA



BESTSELLER

REF. 11047\*

EAN: 5907442110470

83 x 76 x 36 CM PCB: 6 PCS  
1,582 / 2,072 KG



\* GB THE TOY CONTAINS 1 OF THE VEHICLES SHOWN ON THE PACKAGING.



BESTSELLER

REF. 11850\*

EAN: 5907442118506

100 x 100,5 x 42,5 CM PCB: 4 PCS  
2,670 / 3,420 KG



# PARKING



1 ST. PRICE

REF. 12867 \*

EAN: 5907442118476

55 x 35 x 33 CM PCB: 5 PCS  
0,910 / 1,310 KG



\* GB THE TOY CONTAINS 1 OF THE VEHICLES SHOWN ON THE PACKAGING.



REF. 12869 \*

EAN: 5907442118483

55 x 35 x 40 CM PCB: 5 PCS  
1,140 / 1,540 KG





300  
PCS 6cm

REF. 10965

EAN: 5907442109658

33 x 33 x 57 CM PCB: 2 PCS  
1,260 / 1,380 KG



100  
PCS 6cm

REF. 10886

EAN: 5907442108866

30 x 22 x 22 CM PCB: 4 PCS  
0,420 / 0,442 KG



100  
PCS 6cm

REF. 10964

EAN: 5907442109641

25 x 25 x 50 CM PCB: 4 PCS  
0,420 / 0,441 KG



↑  
20 CM  
↓

BESTSELLER

REF. 10335

EAN: 5907442103359

45 x 19.5 x 36 CM    PCB: 5 PCS  
0.651 / 0.658 KG



↑  
36 CM  
↓

10335

↑  
31 CM  
↓

5051

BESTSELLER

REF. 5051

EAN: 5900747000736

29 x 29 x 31 CM    PCB: 11 PCS  
0.520 / 0.525 KG

# Garden Items



# Rainwater tanks

58,5 CM

111,5 CM



WITH WATER TAP

REF. 12934

EAN: 5907442129342

58,5 x 58,5 x 111,5 CM PCB: 1 PCS  
5,800 KG



with accessories



REF. 12955

EAN: 5907442129557

58,5 x 58,5 x 111,5 CM PCB: 1 PCS  
6,100 KG



# Rainwater tanks

with accessories



REF. 13018

EAN: 5907442130188

58,5 x 58,5 x 111,5 CM  
6,100 KG

PCB: 1 PCS



WITH WATER TAP  
REF. 12933

EAN: 5907442129335

58,5 x 58,5 x 111,5 CM  
5,800 KG

PCB: 1 PCS

# Rainwater tanks

58,5 CM

111,5 CM



with accessories



WITH WATER TAP

REF. 12935

EAN: 5907442129359

58,5 x 58,5 x 111,5 CM PCB: 1 PCS  
5,800 KG



REF. 12956

EAN: 5907442129564

58,5 x 58,5 x 111,5 CM PCB: 1 PCS  
6,100 KG

# Watering cans



REF. 12920

EAN: 5907442129205

18 x 63 x 35 CM PCB: 6 PCS  
0,450 KG



REF. 12970

EAN: 5907442129700

14,5 x 45 x 26 CM PCB: 10 pcs  
0,200 KG



REF. 12969

EAN: 5907442129694

11 x 36 x 20 CM  
0,140 KG



REF. 13013

EAN: 5907442130133

18 x 63 x 35 CM PCB: 6 PCS  
0,450 KG

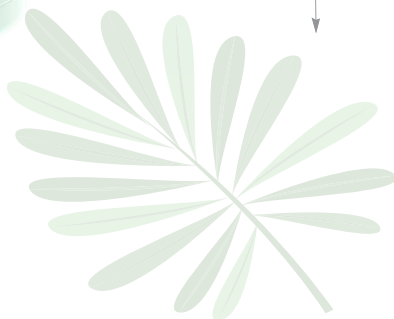

REF. 13017

EAN: 5907442130171

14,5 x 45 x 26 CM PCB: 10 pcs  
0,200 KG



REF. 13016

EAN: 5907442130164

11 x 36 x 20 CM  
0,140 KG

# Watering cans



REF. 13014

EAN: 5907442130140

20 x 63 x 37 CM PCB: 6 PCS  
0,410 KG



37 CM

63 CM

20 CM



REF. 12921

EAN: 5907442129212

20 x 63 x 37 CM PCB: 6 PCS  
0,410 KG

20 CM



64 CM

37 CM

21 CM



REF. 12922

EAN: 5907442129229

21 x 64 x 37 CM PCB: 6 PCS  
0,367 KG



64 CM

37 CM

21 CM



REF. 13015

EAN: 5907442130157

21 x 64 x 37 CM PCB: 6 PCS  
0,367 KG

# Garden armchairs



REF. 12973

EAN: 5907442129731

80 x 81 x 70 CM PCB: 11 PCS  
6.200 KG



REF. 12948

EAN: 5907442129489

80 x 81 x 70 CM PCB: 11 PCS  
6.200 KG



REF. 12972

EAN: 5907442129724

80 x 81 x 70 CM PCB: 11 PCS  
6.200 KG

# Garden armchairs



REF. 13007

EAN: 5907442130072

75 x 65 x 70 CM PCB: 1 PCS



**MOCHTOYS SP.JAWNA A.MOCH K.MOCH:**

REGISTRATION ADDRESS:

NARUTOWICZA 308,

05-400 OTWOCK, POLAND

HEAD OFFICE / WAREHOUSE:

MOSTÓW 14, 05-408 WOLA DUCKA,



**+ (48) 22 779 76 76**

MOCHTOYS@MOCHTOYS.COM, WWW.MOCHTOYS.COM

**ZASTOUPENI V ČESKU I NA SLOVENSKU:**

MOCHTOYS S.R.O., KRAMOLNA 186,

547 01 NACHOD, CZECH REPUBLIC



**+ (48) 601 537 062**

TOMEKC@MOCHTOYS.CZ

**DISTRIBUTEUR POUR LA FRANCE:**

MBI INTERNATIONAL, 1, RUE LOUIS-JOSEPH GAY-LUSSAC

LES PORTES DE L'OUEST, 76150 LA VAUPALIÈRE, FRANCE



**+ (33) 2 32 82 92 92**

MAIL@MBI-INTERNATIONAL.COM

